

PRODUCT SPECIFICATION

Customer	
Project	
Part No.	Z101029-PR03H-总成 3
Remarks	<input type="checkbox"/> APPOVAL FOR SPECIFICATION ONLY <input checked="" type="checkbox"/> APPOVAL FOR SPECIFICATION AND SAMPLE

CUSTOMER			ZHUNYIKEJI		
Approved	Checked	Prepared	Approved	Checked	Prepared
By	By	By	By	By	By
				Shi Jin	Yang Zifeng

Revision Record

Rev. No.	Date	Description
V1.0	2023-03-28	Preliminary Specification Release.

Contents

1. General Specifications.....	3
2. Interface Definition Description.....	4
3. Mechanical Drawing.....	6
4. Electrical Specifications.....	8
5. Delivery Inspection.....	12
6. Reliability Test.....	14
7. Precautions.....	15
8. Packing and Storage.....	17

1. General Specifications

No.	Item	Specification	Unit
1	Display Size (Diagonal)	10.1	inch
2	Display Resolution	800(H) × RGB × 1280 (V)	pixels
3	Pixel Pitch	56.4(H) × 169.2 (V)	um
4	LCM Outline Dimension (Without FPC)	143.05 (W) × 228.55 (H) × 2.60 (T)	mm
5	LCD Outline Dimension	139.36 (W) × 225.58 (H) × 0.8 (T)	mm
6	TLCM Outline Dimension (Without FPC)	153.85 (W) × 243.85 (H) × 4.33 (T)	mm
7	LCD Active Area	135.36 (W) × 216.58 (H)	mm
8	View Direction (Gray Inversion)	FULL VIEW	-
9	Driver IC	JD9365DA-H3	-
10	Pixel Arrangement	RGB-Stripe	-
11	Display Mode	Normal Black	-
12	Pixel driving Element	a-Si TFT	-
13	LCD Transmittance	Typ.: 5.41% Min:4.65%	-
14	LCD Contrast Ratio	Typ.: 1000 Min:800	-
15	FPC Version	Z101029-PR03H V2	-
16	Interface	MIPI	-
17	TP Interface	I2C	-
18	Operating Temperature	-20°C~ 70°C	-
19	Storage Temperature	-30°C~ 80°C	-
20	Backlight Arrangement	LED/9 Series 4 Parallel (36 lights in total)	-
21	Luminance	Typ.:500	nit
22	Weight	0.306	kg

2. Interface Definition Description

2.1 LCM PIN

PIN NO.	PIN DEF.	FUNCTION DESC.
1	NC	No Connection
2-3	VDDIN	POWER SUPPLY (3.3V)
4	NC	No Connection
5	NC(LCD-RST)	No Connection(LCM RESET PIN)
6	NC	No Connection
7	GND	Ground
8	MIPI_0N	Negative MIPI differential data input
9	MIPI_0P	Positive MIPI differential data input
10	GND	Ground
11	MIPI_1N	Negative MIPI differential data input
12	MIPI_1P	Positive MIPI differential data input
13	GND	Ground
14	MIPI_CKN	Negative MIPI differential CLOCK input
15	MIPI_CKP	Positive MIPI differential CLOCK input
16	GND	Ground
17	MIPI_2N	Negative MIPI differential data input
18	MIPI_2P	Positive MIPI differential data input
19	GND	Ground
20	MIPI_3N	Negative MIPI differential data input
21	MIPI_3P	Positive MIPI differential data input
22	GND	Ground
23-24	NC	No Connection
25	GND	Ground
26-27	NC	No Connection
28	ID0	LCM ID PIN
29	ID1	LCM ID PIN
30	GND	Ground
31-32	LEDK	POWER SUPPLY- FOR BACKLIGHT CATHODE
33	TP-GND	Ground
34	TP-SDA	TP I2C data (SDA) data input (MOSI)
35	TP-SCL	TP I2C clock (SCL) clock (SCLK)
36	TP-INT	TP Interrupt PIN
37	TP-RESET	TP Reset PIN
38	TP-VDD	TP POWER SUPPLY
39-40	LEDA	POWER SUPPLY- FOR BACKLIGHT ANODE

RESET voltage should be consistent with VDDI voltage, or there probably is black screen fault when power on.

2.2 TP PIN

PIN NO.	PIN DEF.	FUNCTION DESC.
1	GND	Ground
2	SDA(1.8V)	TP I2C data (SDA) data input (MOSI)(1.8V)
3	SCL(1.8V)	TP I2C clock (SCL) clock (SCLK)(1.8V)
4	INT(1.8V)	TP Interrupt PIN(1.8V)
5	RST(1.8V)	TP Reset PIN(1.8V)
6	VDD(2.8V)	TP POWER SUPPLY(2.8V)

4. Electrical Specifications

4.1. LCD Optical Characteristics

Item	Symbol	Conditions	Specification			Unit	Note
			Min.	Typ.	Max.		
Transmittance (With PL)	T(%)	Viewing normal angle $x = y = 0$	4.65	5.41	-	%	-
Contrast Ratio	CR		800	1000	-	-	-
Response Time	TR+TF		-	25	35	ms	-
Viewing Angle	Hor.	Θ_{x+}	-	80	-	deg.	-
		Θ_{x-}	-	80	-		
	Ver.	Θ_{y+}	-	80	-		
		Θ_{y-}	-	80	-		

4.2. Electrical Specifications

Item	Symbol	Specification			Unit
		Min.	Typ.	Max.	
Power For Analog Circuit	AVDD	4.5	-	6.3	V
TFT Gate On Voltage	VGH	15.5	16	16.5	V
TFT Gate Off Voltage	VGL	-12.5	-12	-11.5	V
TFT Common Electrode Voltage	Vcom	-1.2	-0.7	-0.2	V

4.3. Typical Operating Conditions

Item	Symbol	Min.	Typ.	Max.	Unit
Analog Supply Voltage	VDDIN	2.5	3.3	6.0	V
I/O Supply Voltage	VDDI	1.65	1.8	3.6	V
Input High Voltage	VIH	$0.7 \times VDDI$	-	VDDI	V
Input Low Voltage	VIL	0	-	$0.3 \times VDDI$	V

Output High Voltage	VOH	$0.8 \times VDDI$	-	VDDI	V
Output Low Voltage	VOL	0	-	$0.2 \times VDDI$	V

4.4. Backlight Circuit Specifications

Item	Symbol	Min.	Typ.	Max.	Unit	Test Condition
Current	I _B	-	80	-	mA	-
Voltage	V _f	24.3	28	29.7	V	-
LCM Uniformity	-	80	-	-	%	If=80mA
Life Time	-	30000	-	-	Hr.	
Power Consumption	PBL	-	2240	-	mW	
Chromaticity Coordinate	Red	R _x	0.598	0.613	0.628	Average the brightness EV at 9 points, Optical Instrument BM-7
		R _y	0.341	0.356	0.371	
	Green	G _x	0.322	0.337	0.352	
		G _y	0.580	0.595	0.610	
	Blue	B _x	0.130	0.145	0.160	
		B _y	0.050	0.065	0.080	
	White	W _x	0.288	0.303	0.318	
		W _y	0.317	0.332	0.347	

4.5. LCD Power Consumption

Mode	Symbol	Typ.	Max.	Unit
Normal Mode	VDDIN+VDDI	-	-	mA
Test Condition: VDDIN=3.3V.				
Interface Drive Type: row flipping or column flipping.				
IPS Type LCD Panel => All Black Pattern.				
TN Type LCD Panel => All White Pattern.				
Temperature: 25°C.				
Mode	Symbol	Typ.	Max.	Unit

Sleep Mode	VDDIN+VDDI	-	-	μA
Test Condition: VDDIN=3.3V.				
DC/DC converter is enabled. Internal oscillator is started and panel scanning is started.				
Except for the IC internal crystal oscillator and panel scanning, other functions are suspended.				
Temperature: 25°C.				

4.6. Measuring System

4.6.1. LCM Viewing Angle

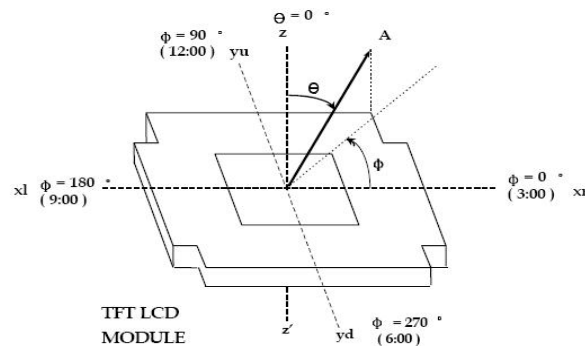

Viewing angle is the angle at which the contrast ratio is greater than 10. The angles are determined for the horizontal or x axis and the vertical or y axis with respect to the z axis which is normal to the LCD surface.

4.6.2. Response Time

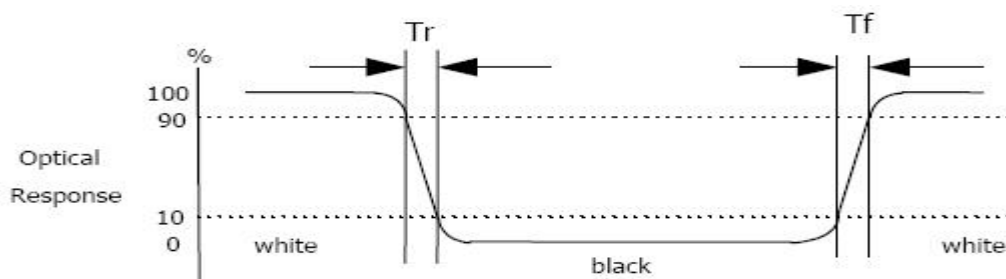

Response time is the time required for the display to transition from white to black (Rising time, T_r) and from black to white (Falling time, T_f) for additional information.

4.6.3. Contrast Ratio (CR)

Contrast Ratio (CR) is defined mathematically as:

$$\text{Contrast Ratio} = \frac{\text{Surface Luminance with all white pixels}}{\text{Surface Luminance with all black pixels}}$$

Surface luminance is the center point across the LCD surface 500mm from the surface with all pixels displaying white.

4.7. Power On / Power Off

4.7.1. Power On

Symbol	Min	Typ	Max	Unit	Remark
tRamp	-	no limit	-	us	
tPWON	0	-	-	ms	
tON1	0	-	-	ms	
tMIPI-ON	0	-	tRPWIRES	ms	
tRPWIRES	5	-	-	ms	
tRESETL	10	-	-	us	
tRESETH	5	-	-	ms	
tSLPOUT	120	-	-	ms	
tBLON	0	-	-	ms	

BOOSTM[1:0]=10 (Internal DC/DC power mode : Charge Pump, FP7721)
 VCCD=IOVCC=VCCH=1.65V ~ 3.6V, VCI=VCIP=2.5V ~ 4.8V.
 Power on:

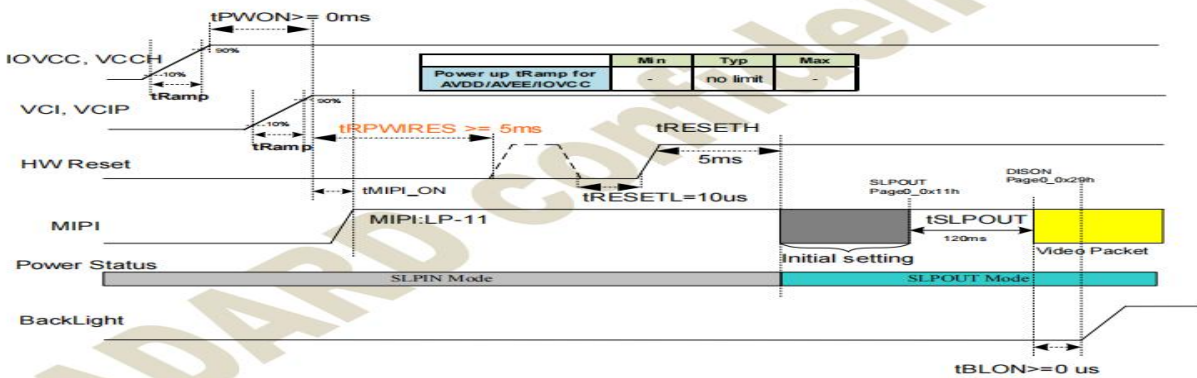

4.7.2. Power Off

Symbol	Min	Typ	Max	Unit	Remark
tRamp	-	no limit	-	us	
tPWOFF	0	-	-	ms	
tPWOFF1	0	-	-	ms	
tPWOFF2	0	-	-	ms	
tMIPIOFF1	0	-	-	ms	power off case 1
tRSTOFF1	120	-	-	ms	power off case 1
tMIPIOFF2	0	-	-	ms	power off case 2
tRSTOFF2	0	-	-	ms	power off case 2
tCMD_OFF	1	-	-	ms	power off case 2
tDISOFF	50	-	-	ms	power off case 2
tSLPIN	100	-	-	ms	power off case 2
tBLOFF	0	-	-	ms	

BOOSTM[1:0]=10 (Internal DC/DC power mode : Charge Pump, FP7721)
 VCCD=IOVCC=VCCH=1.65V ~ 3.6V, VCI=VCIP=2.5V ~ 4.8V.
 Power off: Case 1

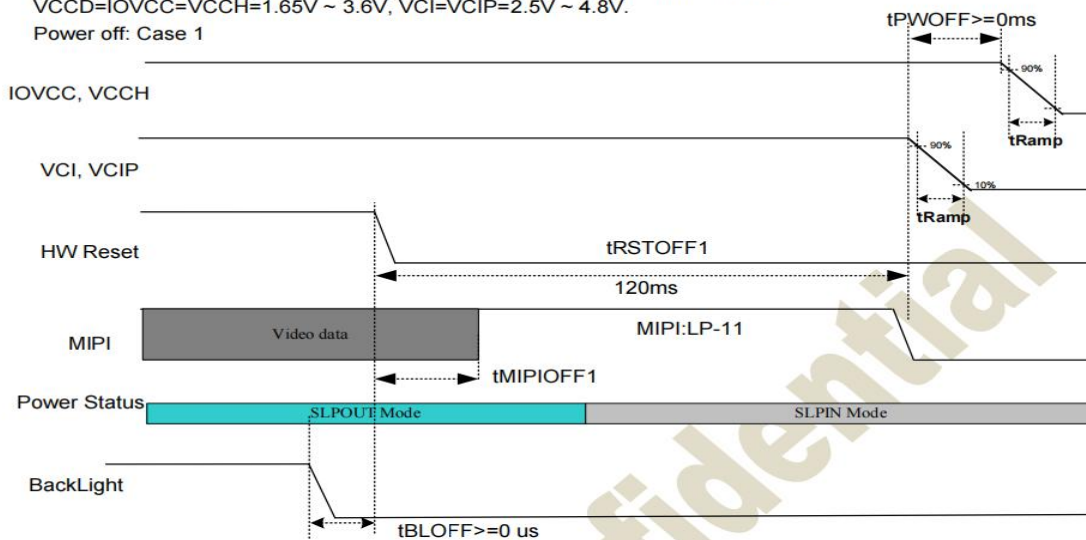

5. Delivery Inspection

5.1. Quality Inspection Environmental Conditions

- 5.1.1. Viewing distance: the normal viewing distance between the screen and the inspector is $30\pm 5\text{cm}$; Inspection Angle: $90^\circ\pm 45^\circ$ (90° indicates that the inspector's perspective is perpendicular to the product to be inspected).
- 5.1.2. Visual inspection illumination: $1000\pm 200\text{LUX}$; Electrical inspection illumination: $200\pm 100\text{LUX}$; Ambient temperature $25\pm 5^\circ\text{C}$, ambient humidity $55\pm 15\%\text{RH}$.

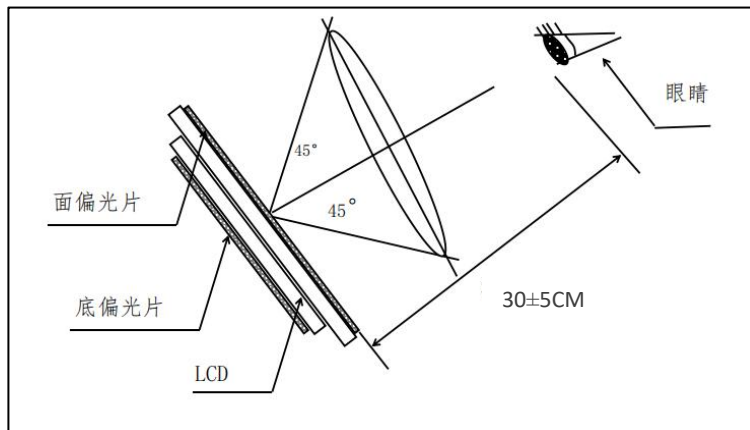

5.2. Quality Inspection Standard

No.	Defect	Standard		Defect Grade	Result
1	Spot Defect (including bright spot / color spot / bubble / dark spot, etc.)	< 7 inches	$\Phi \leq 0.10\text{mm}$	Ignore	OK
			$0.10\text{mm} < \Phi \leq 0.20\text{mm}$	Minor Defect	OK
			$\text{DS} \geq 10\text{mm}$		
		$\cong 7$ inches	$\Phi > 0.20\text{mm}$	Serious Defect	NG
			$\Phi \leq 0.15\text{mm}$	Ignore	OK
			$0.15\text{mm} < \Phi \leq 0.25\text{mm}$	Minor Defect	OK
$\text{DS} \geq 10\text{mm}$					
Φ : defect diameter. DS: spacing.					
2	Linear Defect (scratches,	< 7 inches	$W \leq 0.02\text{mm}$, L: unlimited	Ignore	OK

	filaments, etc.)		0.02mm < W ≤ 0.03mm		Minor Defect	OK		
			L ≤ 5mm					
		≧ 7 inches	W > 0.03mm		Serious Defect		NG	
			W ≤ 0.03mm		Ignore		OK	
			L: unlimited					
		0.03mm < W ≤ 0.05mm		Minor Defect		OK		
L ≤ 5mm								
W > 0.05mm		Serious Defect		NG				
W: defect width. L: defect length. DS: spacing.								
3	Polarizer Bubble	Display Area	Judge by Spot Defect					
		Black Edge Area	The distance from the edge of the display area is greater than 0.5mm.		Minor defect	OK		
			The distance from the edge of the display area is less than 0.5mm.		Judge by Spot Defect			
4	Polarizer Bump (Mark)	Display Area / Black Edge Area	Invisible when the touch screen or cover plate is assembled.		Minor Defect	OK		
5	Color and Luminance	Item	Method	Instrument	Median	Tolerance Range		
		Color	x, y Color Coordinate	Optical Instrument BM-7	According to the actual test on the sample confirmed by the customer.	± 0.04		
		Luminance	Average the brightness EV at 9 points	Optical Instrument BM-7	According to the actual test on the sample confirmed by the customer.	± 20%		
6	Other Standards	Subject to the negotiation by both parties.						

7	Warranty Period	One year after sale.
8	Guarantee	ROHS、REACH
9	Websites	https://www.zhunyikeyi.com https://www.zhunyikeyi.com https://www.zhunyikeyi.com

6. Reliability Test

Item	Condition	Result Determination
High-Temperature Storage	80°C 120H	After the test, leave the LCD samples indoors at normal temperature and humidity for 2H for function and appearance inspection. The sample should meet the requirements on electrical performance, but be free from the following defects: 1. Air bubble in the module, 2. No display, 3. Glass crack.
Low-Temperature Storage	-30°C 120H	
High-Temperature Operation	70°C 120H	
Low-Temperature Operation	-20°C 120H	
High-Temperature and High-Humidity	60°C 90%RH 120H	
Thermal Cycling Test	-20°C/0.5H ~ +70°C/0.5H 100 cycles in total	
Vibration Test	Frequency: 10Hz ~ 55Hz ~ 10Hz Amplitude: 0.75mm Cycle once a minute, 30 cycles in total (Packing Condition)	
ESD Test	±4kV Human Body Mode 150pF/330Ω	
	±8kV Air Mode 150pF/330Ω	

Note:

- 1) Each module under test can only be used for one of the test items.
- 2) The quantity of samples for each test item is 2.
- 3) **Fault Judgment Criterion: Basic Specifications, Electrical Specifications, Mechanical Specifications, Optical Specifications.**

7. Precautions

- 7.1. The display screen consists of glass and polarizer. Since the glass is fragile, the user must pay special attention to the edge area, and protect it from falling, vibration, or mechanical impact.
- 7.2. If the display screen is damaged and the liquid crystal material leaks, be sure not to get any in the mouth. If the liquid crystal material contacts the skin or clothes, flush off with soap and water.
- 7.3. Do not apply excessive force to the display screen or the joint part, or the color will change. Do not touch the display screen with bare hands, which will stain the display area and degraded insulation between terminals (some of the appearance is determined by the polarizer).
- 7.4. The polarizer covering the display panel of the LCD module is soft and easy to be scratched, be sure to handle carefully. Do not touch, impact, press, or rub the exposed polarizers with anything harder than an HB pencil lead (e.g.: glass, tweezers, etc.). Do not place or attach anything onto the display area to avoid leaving marks. The condensed material on the surface or terminals due to cold will damage or stain the polarizer. After the test in low temperature environment, the product must be warmed up in a container before put into the room temperature environment.
- 7.5. If the display panel is stained, blow warm air onto the surface and gently wipe it with a soft and dry cloth. If it is seriously contaminated, wipe it with a wet cloth dipped in one of the following solvents:
 - glycerol
 - ethyl AlcoholDo not scrub, and avoid damaging the display panel.
- 7.6. Solvents other than those mentioned above may damage the polarizer. In particular, never use any of the following solvents:
 - water
 - ketone
 - areneWipe off saliva or water drop immediately, the contact with water over a long period of time may cause deformation or color fading. Avoid contact with oil or grease.
- 7.7. Special note: minimize electrode corrosion. Because electrode corrosion can be accelerated by water droplets, condensation of humidity, or electrification in a high humidity environment.
- 7.8. Assemble the LCD Module by the mounting holes. Make sure the LCD module make sure there is no bending, distortion, or deformation. Do not forcibly pull or bend the transmission wire or the backlight wire.

- 7.9. Do not disassemble the LCD module.
- 7.10. NC terminal should be disconnected. Do not connect any device.
- 7.11. If the logic circuit power supply is off, do not send the input signal.
- 7.12. Since the LCD module is integrated with CMOS, pay special attention to the modules. To prevent electrostatic damage, be careful to maintain a suitable work environment.
- Make sure the module has the same potential as the human body before take the LCD module out of the packing box for assembly. The reliable grounding is necessary during module processing.
 - The required tool, such as the electric soldering iron, must be reliably grounded. Make sure it is connected to AC power supply, and no electric leakage. When fixing the module with electric screwdriver, it must be grounded, to reduce the electromagnetic wave generated by the electric commutator spark as much as possible.
 - Do not assemble or operate under dry condition to reduce the static electricity. To reduce static electricity, the workplace must not be too dry. The recommended relative humidity is 50 - 60%.
Keep your work clothes and work table grounded as much as possible
 - The LCD module is coated with a film to protect the display surface. Be careful when peeling off the film to reduce the generated static electricity.
- 7.13. Since the LCD module has high precision assembly and regulation, try to avoid excessive impact on the module or making any changes:
- Do not change the shape of the tab on the metal frame.
 - Do not drill any extra hole, modify the shape, or change the position of component on the printed circuit board.
 - Do not change or damage the pattern on the printed circuit board.
 - Never modify the zebra strip (conductive rubber) or heat seal connector.
 - Do not make any change with the electric soldering iron except for the joint.
 - Do not throw, bend or twist.

8. Packing and Storage

8.1. Packing Method

Step 1



Take 1pcs of the product, put it into a anti-static bag.

Step 2

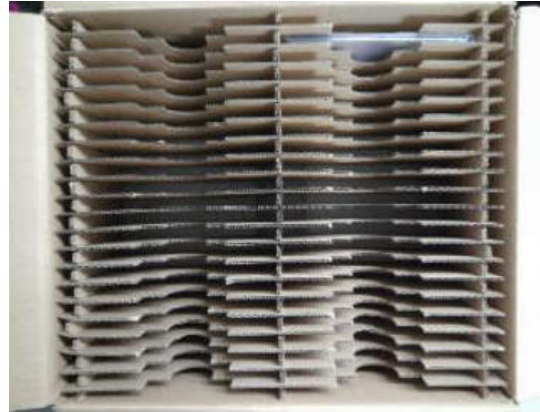

Take 2 bags of product to place into the carton, make sure they are surface to surface. Put a piece of EPE pad between the carton and the separator to protect the products.

Step 3



Put the products into cartons one by one, each carton contains 60 pieces of products.

Step 4



The cartons should be taped and shipped with labels.

8.2. Storage Method

Store in an ambient temperature of $23\pm 5^{\circ}\text{C}$, and in a relative humidity of $60\pm 15\%$. The storage period should not exceed 12 months. Do not expose to the sun for a long period of time.

8.2.1. Store in clean environment, free from dust, active gas, or solvent.

8.2.2. Store in anti-static environment.

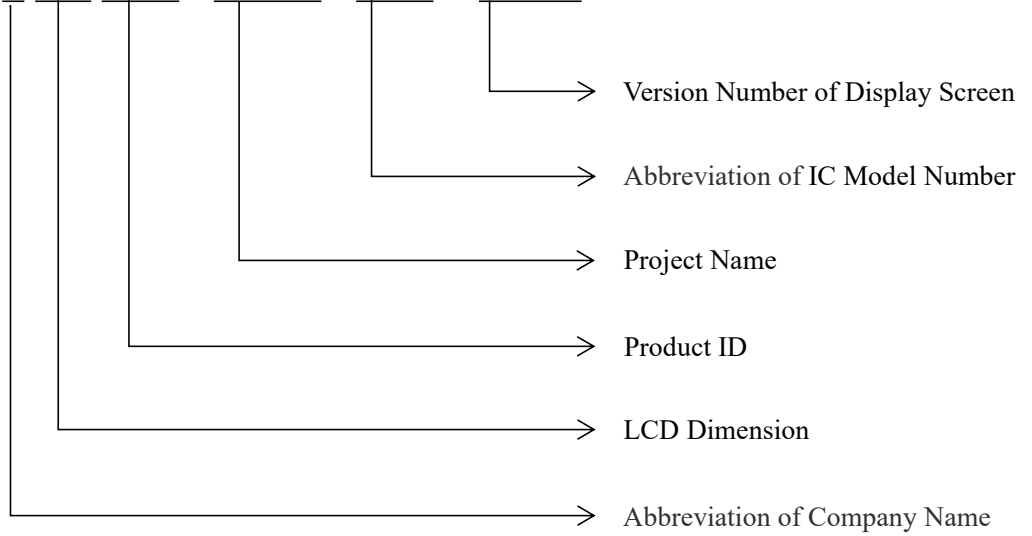

8.3. Nomenclature

PART NO: Z 101 0 2 9 - PR03H - XXX - 总成 3



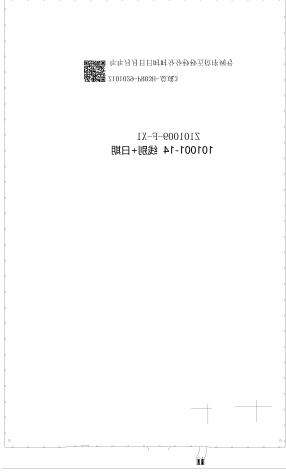
8.4. Label

Shenzhen Zhunyi Technology Co., Ltd.		
Product:	Display Screen	LEVEL:3
Spec.:		
P/N:		
Lot:		
D/C		
Qty.:		
Supplier Code:		
PO		
R/K		
Version: A	XXXXXXXX, YYYY-0000000000000000, KKKK, WWWW,	AAAAA.



8.5. Product appearance identification

Item	Description	Production QR Code Position Display
 QR Code Content	Z101029-总成 3 YYMMDD+Time+5 digits serial number	
Printing Code appearance and content	Z101029-PR03H-总成 3 YYMMDD+Time+5 digits serial number	
<ol style="list-style-type: none"> Customer have detail position and direction requirements(Refer to right picture for details) . Control content,format,position of the QR Code strictly. 		