

PRODUCT SPECIFICATION

Customer	
Project	
Part No.	Z43016-P40-S783-Y2
Remarks	<input type="checkbox"/> APPOVAL FOR SPECIFICATION ONLY <input checked="" type="checkbox"/> APPOVAL FOR SPECIFICATION AND SAMPLE

CUSTOMER			ZHUNYIKEJI		
Approved	Checked	Prepared	Approved	Checked	Prepared
By	By	By	By	By	By
				Wen Xiaoli	Yang Zifeng

Revision Record

Rev. No.	Date	Description
V1.0	2022-05-31	Preliminary Specification Release.

Contents

1. General Specifications	3
2. Interface Definition Description	4
3. Mechanical Drawing	5
4. Electrical Specifications	6
5. Delivery Inspection	10
6. Reliability Test	12
7. Precautions	13
8. Packing and Storage	15

1. General Specifications

No.	Item	Specification	Unit
1	Display Size (Diagonal)	4.3	inch
2	Display Resolution	480(H) × RGB × 272 (V)	pixels
3	Pixel Pitch	198(H) × 198 (V)	um
4	LCM Outline Dimension (Without FPC)	105.46 (W) × 67.16 (H) × 2.75 (T)	mm
5	LCD Outline Dimension	100.16 (W) × 61.86 (H) × 0.8 (T)	mm
6	LCD Active Area	95.04 (W) × 53.86 (H)	mm
7	View Direction (Gray Inversion)	FULL VIEW	-
8	Driver IC	ST7283-G4-1-E	-
9	Pixel Arrangement	RGB-Stripe	-
10	Display Mode	Normal Black	-
11	Pixel driving Element	a-Si TFT	-
12	LCD Transmittance	Typ.: 5.8% Min:5.2%	-
13	LCD Contrast Ratio	Typ.: 1000 Min:800	-
14	FPC Version	Z43016-P40 V3	-
15	Interface	RGB	-
16	Operating Temperature	-30°C~ 85°C	-
17	Storage Temperature	-30°C~ 85°C	-
18	Backlight Arrangement	LED/5 Series 2 Parallel (10 lights in total)	-
19	Luminance	450	nit
20	Weight	0.040	kg

2. Interface Definition Description

PIN NO.	PIN DEF.	FUNCTION DESC.
1	LEDK	POWER SUPPLY- FOR BACKLIGHT CATHODE
2	LEDA	POWER SUPPLY+ FOR BACKLIGHT ANODE
3	GND	Ground
4	VDD	POWER SUPPLY(3.3V)
5-12	R0-R7	DATA BUS
13-20	G0-G7	DATA BUS
21-28	B0-B7	DATA BUS
29	GND	Ground
30	CLK	Pixel clock signal in RGB I/F
31	DISP	Display on/off
32	HSYNC	Horizontal sync. Signal in RGB I/F.
33	VSYNC	Vertical sync. Signal in RGB I/F.
34	DEN	Data enable
35	NC	No Connection
36	GND	Ground
37	XR/NC	LCM XR PIN/No Connection
38	YD/NC	LCM YD PIN/No Connection
39	XL/NC	LCM XL PIN/No Connection
40	YU/NC	LCM YU PIN/No Connection

RESET voltage should be consistent with VDDI voltage, or there probably is black screen fault when power on.

3. Mechanical Drawing

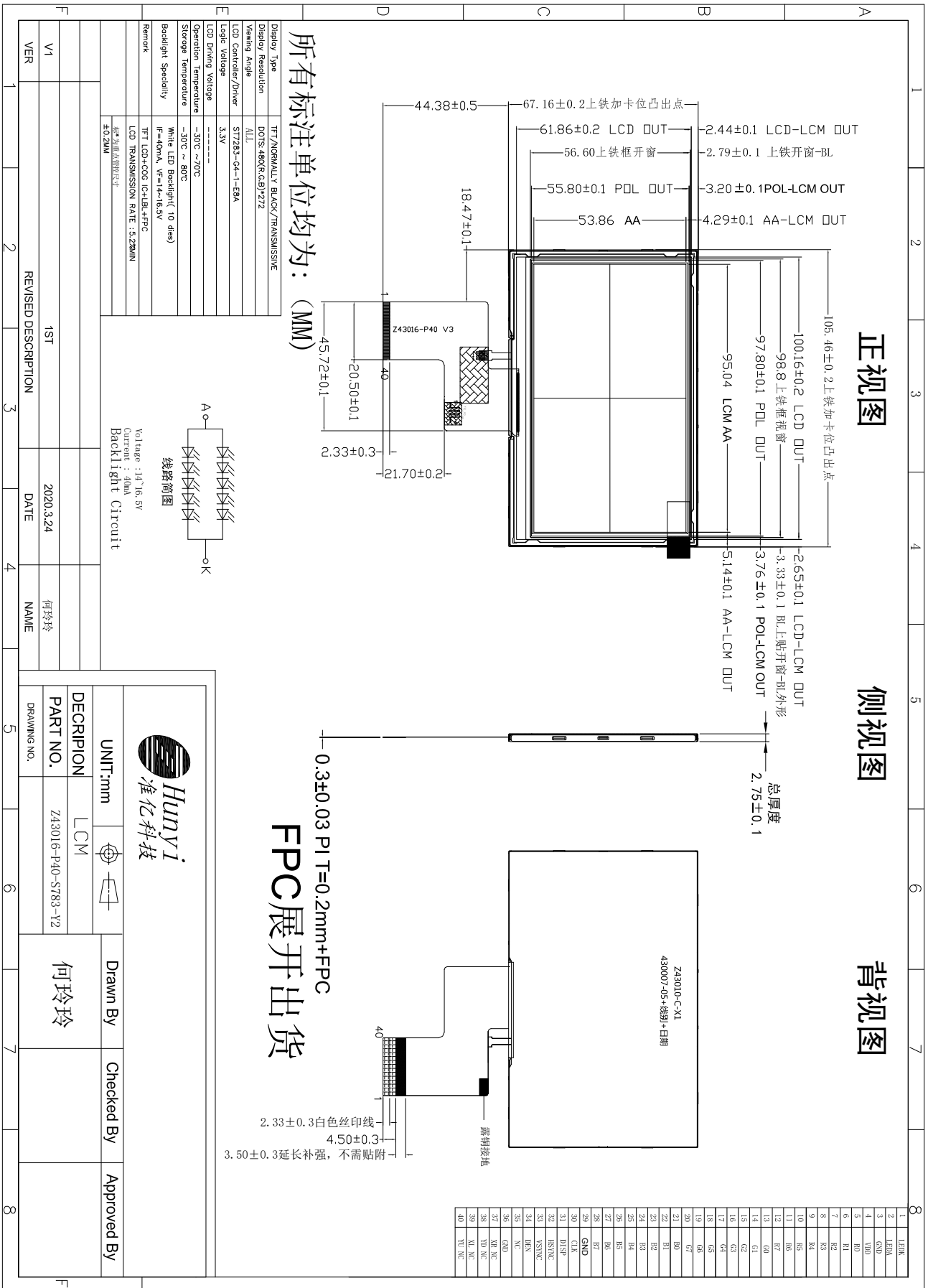

4. Electrical Specifications

4.1. LCD Optical Characteristics

Item	Symbol	Conditions	Specification			Unit	Note	
			Min.	Typ.	Max.			
Transmittance (With PL)	T(%)	Viewing normal angle $x = y = 0$	5.2	5.8	-	%	-	
Contrast Ratio	CR		800	1000	-	-	-	
Response Time	TR+TF		-	-	40	ms	-	
Viewing Angle	Hor.	Θ_{x+}	CR \geq 10 at 25°C	80	85	-	deg.	-
		Θ_{x-}		80	85	-		
	Ver.	Θ_{y+}		80	85	-		
		Θ_{y-}		80	85	-		

4.2. Electrical Specifications

Item	Symbol	Specification			Unit
		Min.	Typ.	Max.	
Power For Analog Circuit	AVDD	-	6.2	6.4	V
TFT Gate On Voltage	VGH	13	15	16.5	V
TFT Gate Off Voltage	VGL	-7	-10	-11	V
TFT Common Electrode Voltage	Vcom	-0.5	-	0.8	V

4.3. Typical Operating Conditions

Item	Symbol	Min.	Typ.	Max.	Unit
Analog Supply Voltage	VDD	3.0	3.3	3.6	V
I/O Supply Voltage	IOVCC	3.0	-	3.6	V
Input High Voltage	VIH	$0.7 \times \text{IOVCC}$	-	IOVCC	V
Input Low Voltage	VIL	GND	-	$0.3 \times \text{IOVCC}$	V

Output High Voltage	VOH	IOVCC-0.4	-	IOVCC	V
Output Low Voltage	VOL	GND	-	GND+0.4	V

4.4. Backlight Circuit Specifications

Item	Symbol	Min.	Typ.	Max.	Unit	Test Condition
Current	I _B	-	40	-	mA	-
Voltage	V _f	14	15	16.5	V	-
LCM Uniformity	-	80	-	-	%	If=40mA
Life Time	-	30000	-	-	Hr.	
Power Consumption	PBL	-	600	-	mW	
LCM Chromaticity Coordinate	Red	R _x	0.563	0.578	0.593	Average the brightness EV at 9 points, Optical Instrument BM-7
		R _y	0.306	0.321	0.336	
	Green	G _x	0.352	0.367	0.382	
		G _y	0.567	0.582	0.597	
	Blue	B _x	0.137	0.152	0.167	
		B _y	0.088	0.103	0.118	
	White	W _x	0.282	0.297	0.312	
		W _y	0.299	0.314	0.329	

4.5. LCD Power Consumption

Mode	Symbol	Typ.	Max.	Unit
Normal Mode	VDD+IOVCC	-	-	mA
Test Condition: VDD=3.3V.				
Interface Drive Type: row flipping or column flipping.				
IPS Type LCD Panel => All Black Pattern.				
TN Type LCD Panel => All White Pattern.				
Temperature: 25°C.				
Mode	Symbol	Typ.	Max.	Unit

Sleep Mode	VDD+IOVCC	-	-	μA
Test Condition: VDD=3.3V.				
DC/DC converter is enabled. Internal oscillator is started and panel scanning is started.				
Except for the IC internal crystal oscillator and panel scanning, other functions are suspended.				
Temperature: 25°C.				

4.6. Measuring System

4.6.1. LCM Viewing Angle

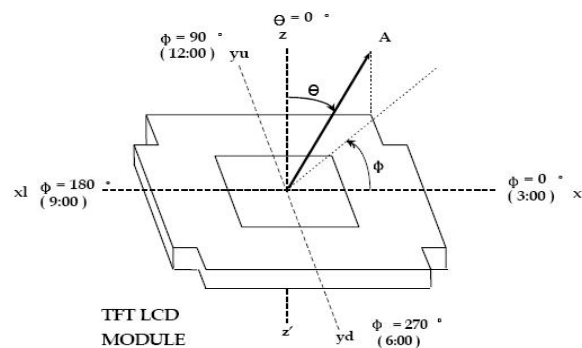

Viewing angle is the angle at which the contrast ratio is greater than 10. The angles are determined for the horizontal or x axis and the vertical or y axis with respect to the z axis which is normal to the LCD surface.

4.6.2. Response Time

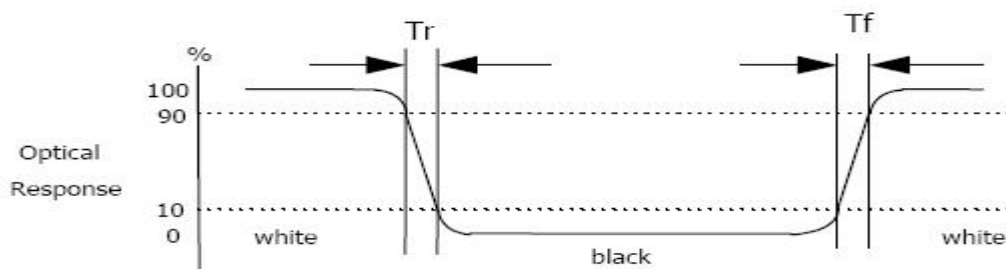

Response time is the time required for the display to transition from white to black (Rising time, T_r) and from black to white (Falling time, T_f) for additional information.

4.6.3. Contrast Ratio (CR)

Contrast Ratio (CR) is defined mathematically as:

$$\text{Contrast Ratio} = \frac{\text{Surface Luminance with all white pixels}}{\text{Surface Luminance with all black pixels}}$$

Surface luminance is the center point across the LCD surface 500mm from the surface with all pixels displaying white.

4.7. Power On / Power Off

4.7.1. Power On

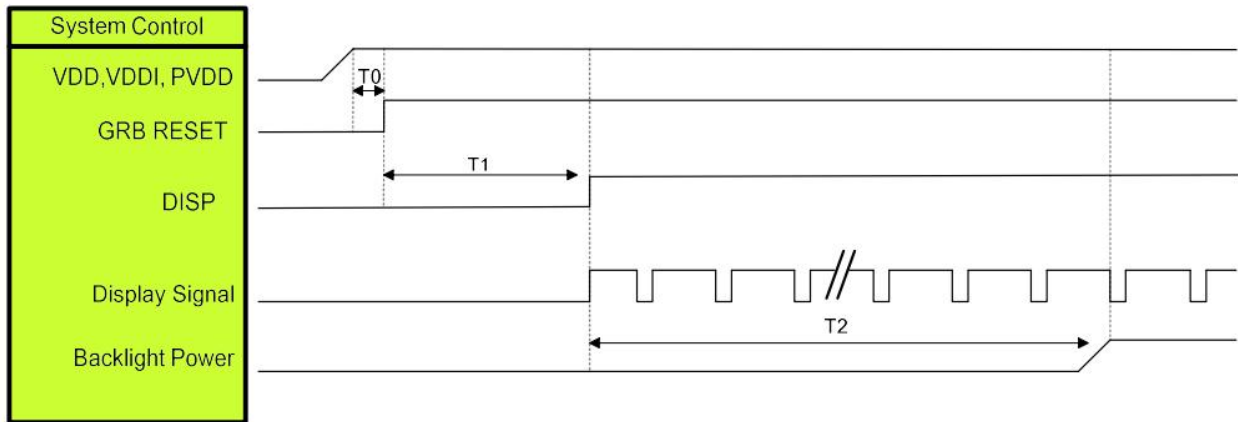

Symbol	Description	Min. Time	Unit
T0	System power stability to GRB RESET signal	0	ms
T1	GRB RESET= "High" to DISP="High"	10	ms
T2	Display Signal output to Backlight Power on	250	ms

4.7.2. Power Off

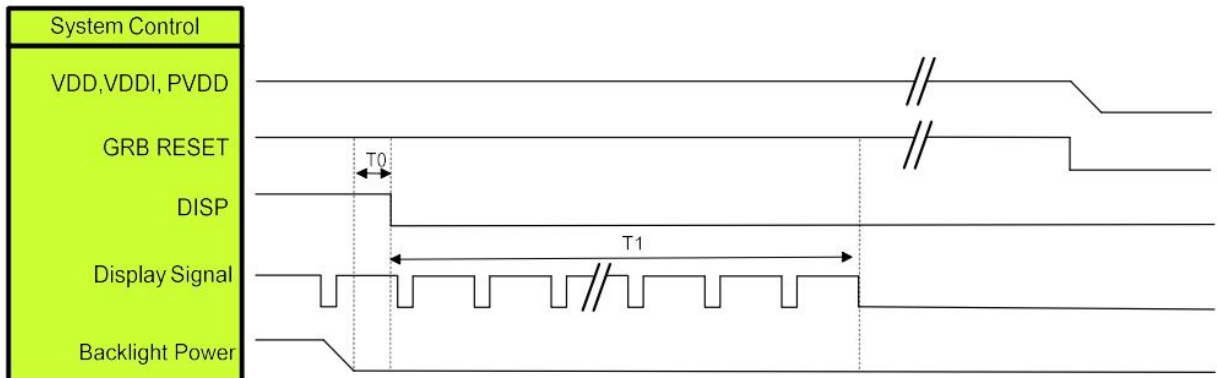

Symbol	Description	Min. Time	Unit
T0	Backlight Power off to DISP="Low"	5	ms
T1	DISP="Low" to IC internal voltage discharge complete	80	ms

5. Delivery Inspection

5.1. Quality Inspection Environmental Conditions

5.1.1. Viewing distance: the normal viewing distance between the screen and the inspector is $30\pm 5\text{cm}$; Inspection Angle: $90^\circ\pm 45^\circ$ (90° indicates that the inspector's perspective is perpendicular to the product to be inspected).

5.1.2. Visual inspection illumination: $1000\pm 200\text{LUX}$; Electrical inspection illumination: $200\pm 100\text{LUX}$; Ambient temperature $25\pm 5^\circ\text{C}$, ambient humidity $55\pm 15\%\text{RH}$.

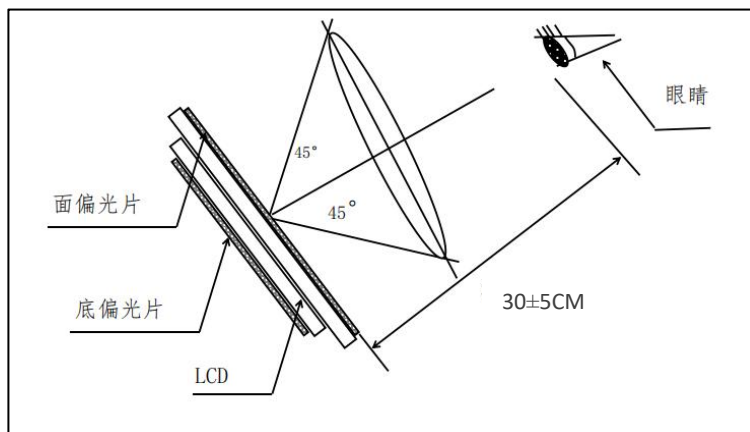

5.2. Quality Inspection Standard

No.	Defect	Standard		Defect Grade	Result
1	Spot Defect (including bright spot / color spot / bubble / dark spot, etc.)	< 7 inches	$\Phi \leq 0.10\text{mm}$	Ignore	OK
			$0.10\text{mm} < \Phi \leq 0.20\text{mm}$	Minor Defect	OK
			$\text{DS} \geq 10\text{mm}$		
		$\cong 7$ inches	$\Phi > 0.20\text{mm}$	Serious Defect	NG
			$\Phi \leq 0.15\text{mm}$	Ignore	OK
			$0.15\text{mm} < \Phi \leq 0.25\text{mm}$	Minor Defect	OK
$\text{DS} \geq 10\text{mm}$					
Φ : defect diameter. DS: spacing.					
2	Linear Defect (scratches,	< 7 inches	$W \leq 0.02\text{mm}$, L: unlimited	Ignore	OK

	filaments, etc.)		0.02mm < W ≤ 0.03mm		Minor Defect	OK
			L ≤ 5mm			
			W > 0.03mm		Serious Defect	NG
			≧ 7 inches	W ≤ 0.03mm		
		L: unlimited				
		0.03mm < W ≤ 0.05mm		Minor Defect	OK	
L ≤ 5mm						
		W > 0.05mm		Serious Defect	NG	
W: defect width. L: defect length. DS: spacing.						
3	Polarizer Bubble	Display Area	Judge by Spot Defect			
		Black Edge Area	The distance from the edge of the display area is greater than 0.5mm.		Minor defect	OK
			The distance from the edge of the display area is less than 0.5mm.			
4	Polarizer Bump (Mark)	Display Area / Black Edge Area	Invisible when the touch screen or cover plate is assembled.		Minor Defect	OK
5	Color and Luminance	Item	Method	Instrument	Median	Tolerance Range
		Color	x, y Color Coordinate	Optical Instrument BM-7	According to the actual test on the sample confirmed by the customer.	± 0.04
		Luminance	Average the brightness EV at 9 points	Optical Instrument BM-7	According to the actual test on the sample confirmed by the customer.	± 20%
6	Other Standards	Subject to the negotiation by both parties.				

7	Warranty Period	One year after sale.
8	Guarantee	ROHS、REACH
9	Websites	Official: https://en.zhunyiikeji.com/ Goble Resources: https://zhunyi.manufacturer.globalsources.com/ Alibaba: https://zhunyiikeji.en.alibaba.com/ 1688: https://shop9641057ru80o3.1688.com/

6. Reliability Test

Item	Condition	Result Determination
High-Temperature Storage	85°C 120H	After the test, leave the LCD samples indoors at normal temperature and humidity for 2H for function and appearance inspection. The sample should meet the requirements on electrical performance, but be free from the following defects: 1. Air bubble in the module, 2. No display, 3. Glass crack.
Low-Temperature Storage	-30°C 120H	
High-Temperature Operation	85°C 120H	
Low-Temperature Operation	-30°C 120H	
High-Temperature and High-Humidity	650°C 90%RH 120H	
Thermal Cycling Test	-30°C/0.5H ~ +85°C/0.5H 100 cycles in total	
Vibration Test	Frequency: 10Hz ~ 55Hz ~ 10Hz Amplitude: 0.75mm Cycle once a minute, 30 cycles in total (Packing Condition)	
ESD Test	±4kV Human Body Mode 150pF/330Ω ±8kV Air Mode 150pF/330Ω	

Note:

- 1) Each module under test can only be used for one of the test items.
- 2) The quantity of samples for each test item is 2.
- 3) **Fault Judgment Criterion: Basic Specifications, Electrical Specifications, Mechanical Specifications, Optical Specifications.**

7. Precautions

- 7.1. The display screen consists of glass and polarizer. Since the glass is fragile, the user must pay special attention to the edge area, and protect it from falling, vibration, or mechanical impact.
- 7.2. If the display screen is damaged and the liquid crystal material leaks, be sure not to get any in the mouth. If the liquid crystal material contacts the skin or clothes, flush off with soap and water.
- 7.3. Do not apply excessive force to the display screen or the joint part, or the color will change. Do not touch the display screen with bare hands, which will stain the display area and degraded insulation between terminals (some of the appearance is determined by the polarizer).
- 7.4. The polarizer covering the display panel of the LCD module is soft and easy to be scratched, be sure to handle carefully. Do not touch, impact, press, or rub the exposed polarizers with anything harder than an HB pencil lead (e.g.: glass, tweezers, etc.). Do not place or attach anything onto the display area to avoid leaving marks. The condensed material on the surface or terminals due to cold will damage or stain the polarizer. After the test in low temperature environment, the product must be warmed up in a container before put into the room temperature environment.
- 7.5. If the display panel is stained, blow warm air onto the surface and gently wipe it with a soft and dry cloth. If it is seriously contaminated, wipe it with a wet cloth dipped in one of the following solvents:
 - glycerol
 - ethyl AlcoholDo not scrub, and avoid damaging the display panel.
- 7.6. Solvents other than those mentioned above may damage the polarizer. In particular, never use any of the following solvents:
 - water
 - ketone
 - areneWipe off saliva or water drop immediately, the contact with water over a long period of time may cause deformation or color fading. Avoid contact with oil or grease.
- 7.7. Special note: minimize electrode corrosion. Because electrode corrosion can be accelerated by water droplets, condensation of humidity, or electrification in a high humidity environment.
- 7.8. Assemble the LCD Module by the mounting holes. Make sure the LCD module make sure there is no bending, distortion, or deformation. Do not forcibly pull or bend the transmission wire or the backlight wire.

- 7.9. Do not disassemble the LCD module.
- 7.10. NC terminal should be disconnected. Do not connect any device.
- 7.11. If the logic circuit power supply is off, do not send the input signal.
- 7.12. Since the LCD module is integrated with CMOS, pay special attention to the modules. To prevent electrostatic damage, be careful to maintain a suitable work environment.
- Make sure the module has the same potential as the human body before take the LCD module out of the packing box for assembly. The reliable grounding is necessary during module processing.
 - The required tool, such as the electric soldering iron, must be reliably grounded. Make sure the it is connected to AC power supply, and no electric leakage. When fixing the module with electric screwdriver, it must be grounded, to reduce the electromagnetic wave generated by the electric commutator spark as much as possible.
 - Do not assemble or operate under dry condition to reduce the static electricity. To reduce static electricity, the workplace must not be too dry. The recommended relative humidity is 50 - 60%.
Keep your work clothes and work table grounded as much as possible
 - The LCD module is coated with a film to protect the display surface. Be careful when peeling off the film to reduce the generated static electricity.
- 7.13. Since the LCD module has high precision assembly and regulation, try to avoid excessive impact on the module or making any changes:
- Do not change the shape of the tab on the metal frame.
 - Do not drill any extra hole, modify the shape, or change the position of component on the printed circuit board.
 - Do not change or damage the pattern on the printed circuit board.
 - Never modify the zebra strip (conductive rubber) or heat seal connector.
 - Do not make any change with the electric soldering iron except for the joint.
 - Do not throw, bend or twist.

8. Packing and Storage

8.1. Packing Method

Step 1

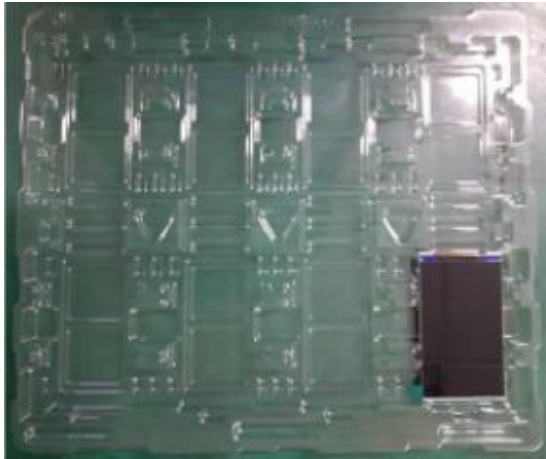

Take 1pcs of the product, put it into a anti-static bag.

Step 2

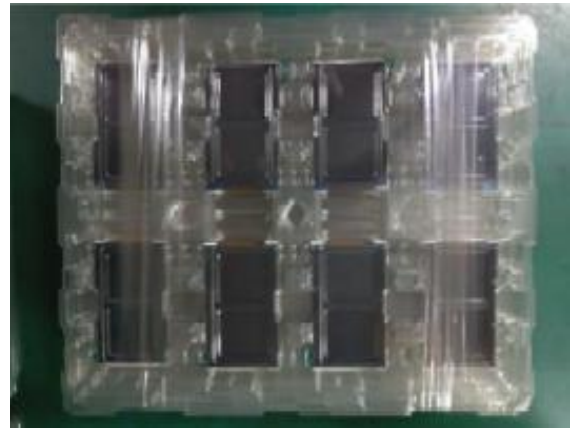

Take 2 bags of product to place into the carton, make sure they are surface to surface. Put a piece of EPE pad between the carton and the separator to protect the products.

Step 3



Put the products into cartons one by one, each carton contains 60 pieces of products.

Step 4



The cartons should be taped and shipped with labels.

8.2. Storage Method

Store in an ambient temperature of $23\pm 5^{\circ}\text{C}$, and in a relative humidity of $60\pm 15\%$. The storage period should not exceed 12 months. Do not expose to the sun for a long period of time.

8.2.1. Store in clean environment, free from dust, active gas, or solvent.



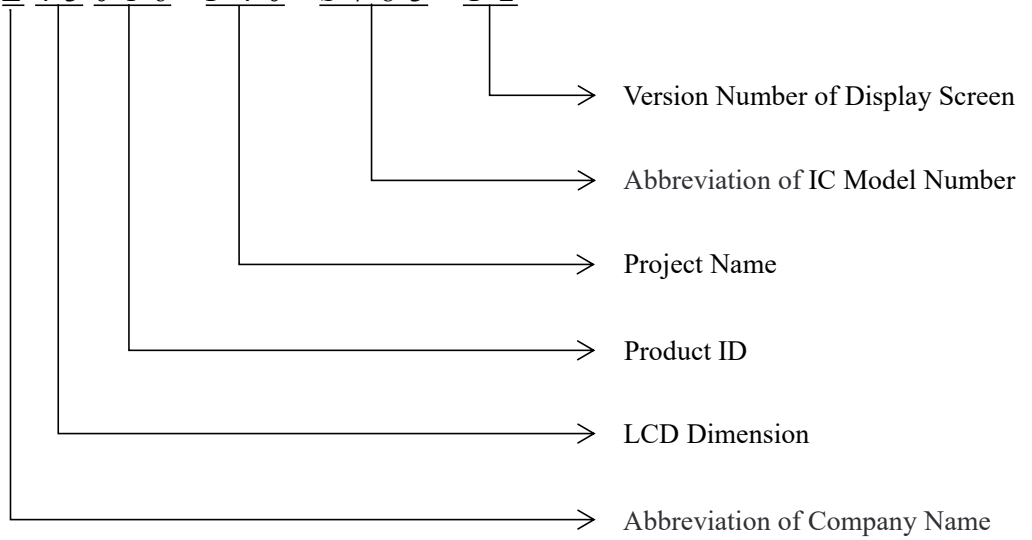

8.2.2. Store in anti-static environment.

8.3. Nomenclature

PART NO: Z 4 3 0 1 6 - P 4 0 - S 7 8 3 - Y 2



8.4. Label

Shenzhen Zhunyi Technology Co., Ltd.		
Product:	Display Screen	LEVEL:3
Spec.:		
P/N:		
Lot:	  	
D/C		
Qty.:		
Supplier Code:		
PO		
R/K		
Version: A	XXXXXXXX, YYYY-0000000000000000, KKKK, WWWW,	AAAAA.